

Operating Manual  
(V1.06.01)

# Universal Thickness Gauge Model range D - 2006



Distributed by:



**Checkline Europe GmbH & Co. KG**®  
Warschauerstrasse 8  
48455 Bad Bentheim  
Deutschland

Tel: +49 5924 9999 690  
Web: <https://www.checkline.de>  
E-mail: [info@checkline.de](mailto:info@checkline.de)

# CONTENTS

<b>1. Warranty and liability</b>	<b>3</b>
1.1 Notes in the operating manual	3
1.2 Obligation of the operator	3
1.3 Obligation of the personnel	3
1.4 Informal safety measures	4
1.5 Staff training	4
1.6 Intended use	4
1.7 Dangers when handling the device	4
1.8 Copyright	4
1.9 Declaration of Conformity	4
<b>2. Commissioning</b>	<b>5</b>
<b>3. Operation</b>	<b>5</b>
3.1 Switch-on process	5
3.2 Main menu	6
3.2.1 Menu	6-7
3.2.1.1 Numerical input	8
<b>4. Starting the measuring process</b>	<b>9</b>
4.1 Preparation before measurement	9
4.1.1 Setting the dwell time	9
4.1.2 Measuring sensor check/replacement	9
4.1.3 Setting the test force/pressure	9
4.1.4 Zero point setting	10
4.2 Automatic measurement	11
4.3 Manual measurement	12
<b>5. Operating software PRO</b>	<b>13</b>
<b>6. Error messages</b>	<b>14</b>
<b>7. Description of the USB interface</b>	<b>15</b>
7.1 Installing the USB driver for program updates	15
7.2 Installing the USB driver for the virtual serial interface	15
7.3 Output of measurement data	16
7.4 Interface	16
7.5 Protocol	17
7.5.1 Example of a data recording	17-18
<b>8. Parameter changes update of the measuring device</b>	<b>18</b>
<b>9. Technical parameters</b>	<b>19</b>

# 1. WARRANTY AND LIABILITY

In principle, our "General Terms and Conditions of Sale and Delivery" apply. These are available to the operator prior to conclusion of the contract.

Warranty:

- 12 months for thickness-testing-devices.

Wear parts, electronic components and measuring springs are excluded from the warranty. Warranty and liability claims for physical injury and damage to property are excluded if they are due to one or more of the following causes:

- Using the device not as intended.
- Improper mounting, commissioning, operation and maintenance of the device (e.g. calibration cycle).
- Operation of the device in the case of defective safety devices or improperly installed or non-functional safety and protection devices.
- Non-observance of the transportation instructions in the operating manual,
- Storage, assembly, commissioning, operation, maintenance and set-up of the device.
- Any unauthorised structural changes to the device.
- Inadequate monitoring of equipment parts subject to wear.
- Opening the device or improperly carried out repairs.
- Disasters caused by foreign bodies and force majeure.

## 1.1 Notes in the operating manual

The basic prerequisite for safe handling of this device and the trouble-free operation is the knowledge of the basic safety instructions and the safety regulations.

This operating manual contains the most important instructions for operating the device in line with the safety regulations.

This operating manual, in particular the safety instructions, must be followed by all persons working with the device. In addition, the accident prevention rules and regulations applicable to the operating site must be observed.

The illustrations in the operating manual are not to scale.

The specified dimensions are non-binding.

General direction information, such as FRONT; REAR; RIGHT; LEFT; apply when the device is viewed from the front side.

## 1.2 Obligation of the operator

In accordance with the EC Directive 89/655/EEC, the operator undertakes only to allow persons to work with the device, who:

- are familiar with the basic provisions on occupational safety and accident prevention and have been instructed in the handling of the device.
- have read the safety chapter and warnings in this operating manual, and confirmed by their signature.
- have been checked at regular intervals for safety-conscious work.

## 1.3 Obligation of the personnel

Prior to starting work, all persons who are to work with the device must undertake to:

- observe the basic regulations on occupational safety and accident prevention.
- read the safety chapter and warnings in this operating manual and confirm by their signature that they have understood them.

#### **1.4 Informal safety measures**

The operating manual should always be kept at the site of operation of the device. In addition to the operating manual, the generally applicable as well as the local regulations for accident prevention and environmental protection must be specified and observed.

#### **1.5 Staff training**

Only trained and instructed personnel may work with the device. The responsibilities of the personnel shall be clearly defined for assembly, commissioning, operation, set-up, maintenance and repair. Personnel to be trained may only work with the device under the supervision of an experienced person.

#### **1.6 Intended use**

The device is exclusively intended for measuring of thickness. Any other use or that extending beyond the intended use is considered to be use not as intended. **Wolf Messtechnik GmbH** is not liable for any damage resulting from this.

Intended use also includes:

- The observance of all instructions in the operating manual and the compliance with the inspection and maintenance work.

#### **1.7 Dangers when handling the device**

The device is constructed according to the state-of-the-art and the recognised safety rules. Nevertheless, its use may pose a risk to the life and limb of the user or third parties or impair the device and other material assets.

The device is only:

- for the intended use in faultless safety-related condition.
- Faults which may impair safety must be rectified immediately.
- The personal protective equipment must be used in accordance with the EC Directive 89/686/EEC.

**The device must not be used in potentially explosive atmospheres or come into contact with aggressive materials.**

#### **1.8 Copyright**

Copyright for this operating manual remains with

**Wolf Messtechnik GmbH**

This operating manual is only intended for the plant operator and his staff.

It contains regulations and instructions, which may only be reproduced with the complete citation of the source after written approval by

**Wolf Messtechnik GmbH.**

Violations may result in criminal prosecution.

#### **1.9 EU - Conformity Declaration**

The device complies with the requirements of the EU Directive 2004/108/EC.

## 2. COMMISSIONING.

Open the transport packaging on the upper side, take out the device and place it on a level and horizontal measuring surface.

Remove the air bubble wrap and the transport restraints (corrugated cardboard around the plunger, foam foil under the measuring sensor).

The foot-operated switch and the mains plug are connected to the corresponding connectors on the rear of the device.

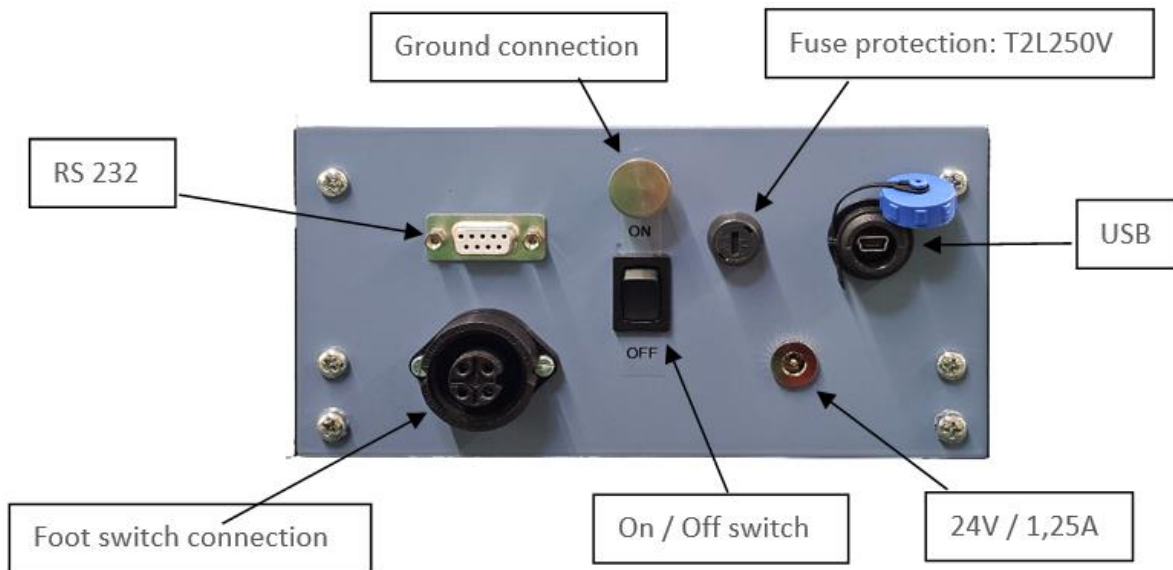

When switched on, the background image is loaded. In addition, the version number of the firmware, the device designation and identification are displayed.

## 3. OPERATION

### Working with the graphic display with touch panel

The **D - 2006** is equipped with a resistive touch screen. The display is made of plastic and must not come into contact with hard objects.

The surfaces can be cleaned with a soft cloth without the use of solvents.

The actions associated with the buttons/switches are triggered when you release them.

A minimum holding time of 150ms is required to prevent unintentional actuation.

### 3.1 Switch-on process

The measuring device is switched on at the rocker switch on the back of the device.

The measuring sensor moves to the uppermost starting position above the measuring table.

When switched on, the background image is loaded. In addition, the version number of the firmware, the device designation and identification are displayed.

### 3.2 Main menu



As long as no measurement data is available, the logo is displayed in the background. If measurement data is available, the last measurement value and the statistical values of the last measurement series are displayed. Operation display (bottom-right) shows the current status of the measuring device. (Green -> ready for a measuring task / Red -> measuring device is in an active measurement)

#### 3.2.1 Menu(D - 2006 differing)

This is where you can access the possible settings. These are clearly arranged on one page and can be selected directly. Numerical entries are conveniently made using a virtual numeric keypad

When you exit the menu, any changed settings are saved. The changes in "Language" and "Unit" are now active.

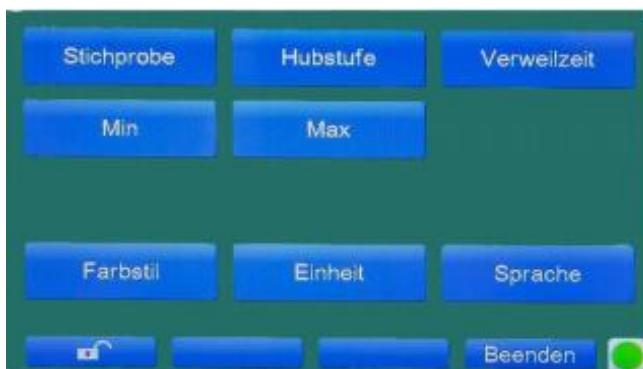

**Sample** = number of measuring points to be measured (with automatic measurement)

**Stroke level** = determines the stroke (based on the level of the measuring table, in mm) of the measuring sensor after a measurement.

The maximum stroke that the measuring device can move is limited by means of a limit switch, so that damage caused by excessive stroke can be ruled out.

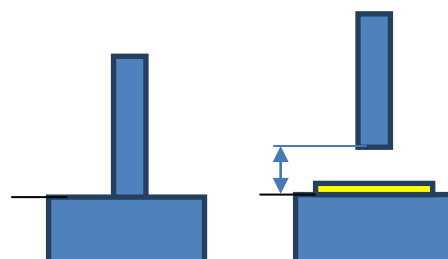

**Dwell time** = how long the measuring sensor should dwell on the object to be measured until the measured value is recorded. (the correct values are stored in the corresponding standards).



**Min** = minimum permissible measured value.

In order to carry out a comfortable test with optically visible limits, the minimum permissible measured value can be entered in this parameter. This "limit" is shown in the diagram. Values recorded outside this limit are marked in red.

**Max** = maximum permissible measured value.

In order to carry out a comfortable test with optically visible limits, the maximum permissible measured value can be entered in this parameter. This "limit" is shown in the diagram, and values that were recorded outside this limit are marked in red.

**Colour style** = adjustment of colours for background / buttons and fonts



The configuration allows to define two colour styles. The settings are called "Day colours" and "Night colours" in the set-up. The settings take effect immediately. Background and button colours can be changed. The brightness can be adjusted, but is the same for both.

The meaning of the buttons:

Set	Accept setting, save
Default	Load factory setting
Day/night	Switching the colour style day/night
Quit	Input is terminated (return to overview)

The colour values are adjusted via sliders.

**Unit** = setting in mm or inch

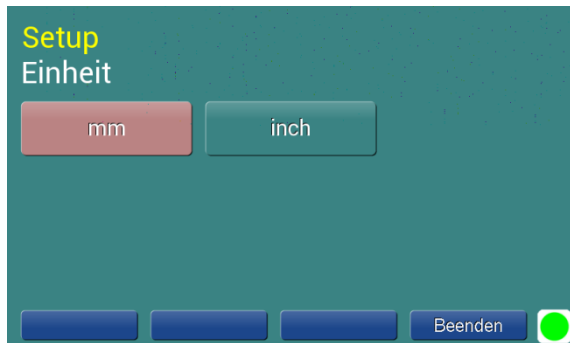

**Language** = German – English - French

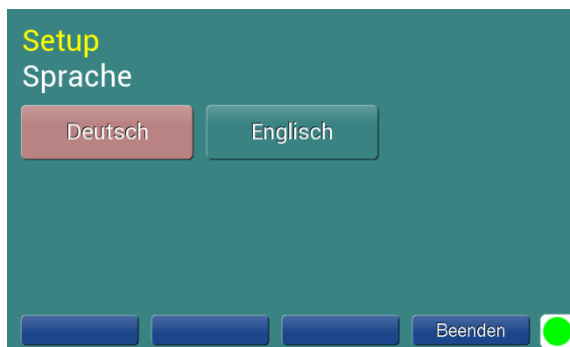

**Lock menu**  
(Locks access to parameters in the menu.)



The open lock symbol indicates that the menu lock is deactivated.  
After entering a numerical code (max. 6 digits) and pressing the Enter button, the menu is locked.  
The parameters in the menu can only be changed by entering the code again.

**ATTENTION: The parameters in the menu can no longer be changed without re-entering the code.  
Please keep the code you enter in a safe place!  
Please train your staff accordingly so that the appliance is not accidentally locked!**

If this does happen, the menu can only be unlocked again by following the procedure described in point 8.  
described under point 8.

You will need a PC with a USB connection, the data cable supplied and the DMG Pro software.

### 3.2.1.1 Numerical input

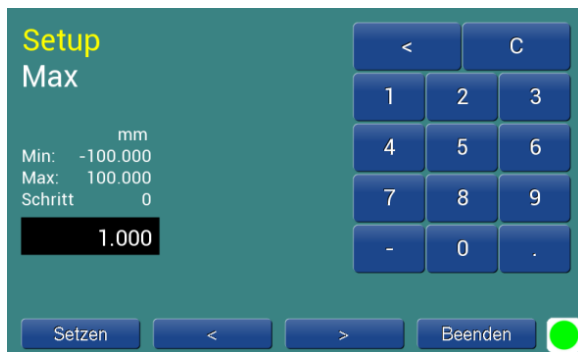

The numeric input consists of the buttons **Set** / < / > / **Exit**, a numeric keypad and the parameter display. The meaning of the buttons:

Set	Accept value, update display
<	Scroll to previous parameter
>	Scroll to the next parameter
Quit	The display is updated (currently valid value is displayed), input is terminated (return to overview)

The meaning of the numeric keypad:

<	Delete last character
C	Delete input completely
-	Prefix
.	Comma
0 - 9	Numeric keypad

## 4. START MEASURING PROCESS

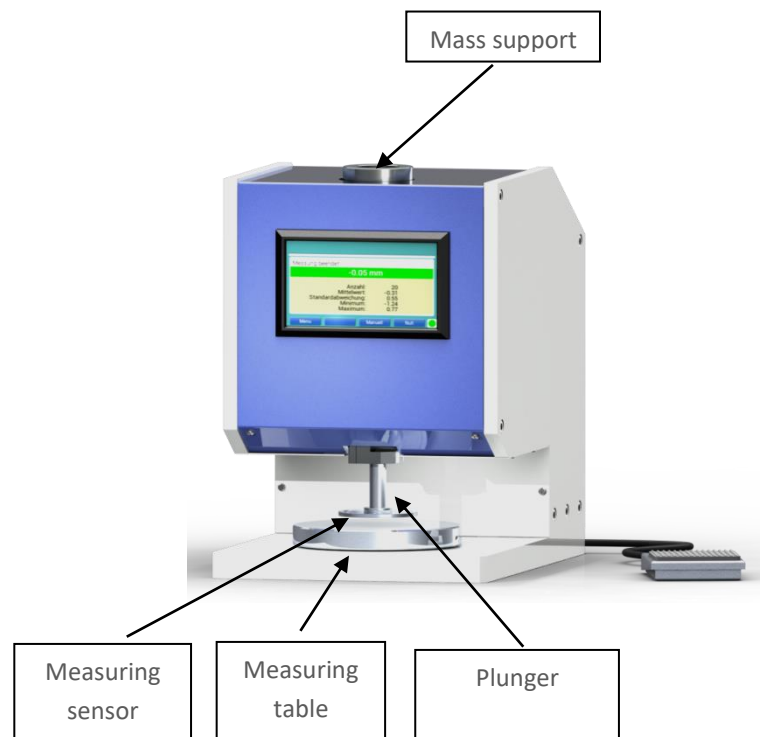

### 4.1 Preparations before measuring

Setting the parameters according to the standard to be applied.

#### 4.1.1 Setting the dwell time (according to the applicable standard).

Refer to section 3.2.1

#### 4.1.2 Checking or changing the correct measuring sensor (according to the applicable standard)

##### 4.1.2.1 Changing the measuring sensor

1. Move the plunger down and switch off the device.
  - press the "Zero" button for this. If the button is on the table, please switch off the device.
2. Removing the measuring sensor
  - The measuring sensor is screwed to the plunger. To remove the measuring sensor, it must be turned clockwise by hand.
3. Attaching the new measuring sensor
  - Lift the plunger with one hand and place the measuring sensor to be installed centrally on the measuring table.
  - Move the plunger down until the threaded bolt touches the plunger.
  - Screw in the sensor by about half a turn.
  - Move the plunger upwards and carefully screw in the measuring sensor until it stops
  - Only carry out assembly by hand, do not use any tools to avoid damage
  - Switch on the device.

#### 4.1.3 Checking or setting the test force or test pressure

Please take the required test force or pressure (according to the applicable standard)

Please place the correct test force (or test pressure), corresponding additional weights on the mass support of the measuring device.

The correct combinations of masses and measuring sensors can be found in the enclosed load table.

#### 4.1.4 Zero point setting.

A new zero point should be set before each measurement.

Before setting the 0-point, the measuring table and the underside of the measuring sensor should be cleaned.

Press the "Zero" button. With this switch, the zeroing is started immediately.

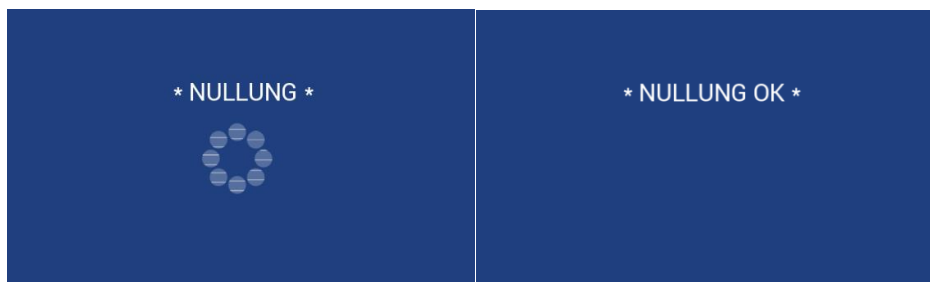

The measuring sensor moves at a speed of 2.5mm/sec to the measuring table and remains there for 2 s until the measuring sensor is set to "0.000" at this point.

## 4.2 AUTOMATIC MEASUREMENT (MODELS D - 2010 AND D - 2020)

Press Auto



The automatic measurement is started immediately. A submenu with *Scal. Y / Scal. X / Numeric / Exit* controls the graphical display or is used to stop the measurement.

### *A few words about the graphic representation*

The min/max limits defined in the configuration determine the scaling and thus, the graphical representation. The scaling can be switched between fixed and automatic. Switchover can also be done during operation. The measured values are displayed as a point and connected with a line.

Scal. Y	<p>Switches between <b>fixed</b> and <b>automatic</b> Y-scaling.</p> <p><b>Fixed scaling (default)</b> Scaling takes place according to the configured limits. Measured values which are within the limits become black, values which are outside the limits become red or "disappear" from the display if they are outside the display range.</p> <p><b>Automatic scaling</b> The largest and the smallest value define the min/max limits; it is scaled again. The min/max limits are re-labelled. If the values are within the configured min/max limits, there is no scaling.</p>
Scal. X	<p>Switches between <b>fixed</b> and <b>automatic</b> X-scaling.</p> <p><b>Fixed scaling (default)</b> The sample (number of measurements to be carried out) determines the step size.</p> <p><b>Automatic scaling</b> Depending on the number of measurements already carried out, these are automatically distributed over the X-axis.</p>
Numeric	Switches to the numeric display.
Quit	<p>As long as the measurement is still in progress, the current measurement is stopped with "Exit". The current measuring cycle is ended and the machine stops. The display remains unchanged.</p> <p>If the machine is in stop mode, press "Exit" to return to the main menu. The display is numeric.</p>

## 4.3 MANUAL MEASUREMENT

Press manual



This is the access point for manual measurement. The individual measurement is triggered with Start (or by pressing the foot-operated switch). The display is graphical and numerical. The scaling works as described for the automatic measurement. To return to the main menu, press "Exit".

SWITCH

[SCAL. Y / SCAL. X] / START / EXIT

## 4.4 ADAPTING THE MEASURING DEVICE TO OTHER MEASURING TASKS

The measuring device can be adjusted to different measuring tasks by changing the test force or pressure, the measuring sensor and the dwell time.

**Use the load table Point 4 from the calibration certificate supplied for this purpose.**

## 5. OPERATING SOFTWARE DMG-PRO (OPTIONAL AVAILABLE)



	Name		Explanation
#1	Connection COM settings	Port	Port number of the virtual serial interface (VCOM)
		Log	Show and hide virtual serial port output
		Connect	Establish connection to the device: USB-HID interface
		Disconnect	Disconnect connections
#6	Log		Virtual serial port outputs
#2	Macro	Read buffer	<b>Reading the measured value memory of the device</b> Display measured values graphically Calculate mean value and sigma Display last measured value
		Clear buffer	<b>Deleting the measured value memory of the device</b> Deleting the graphic display and measured values
		Set zero	Corresponds to the "ZERO" / "NULL" button on the display Starts <b>zeroing</b> , measured value memory is deleted
		Start sampling	Corresponds to the "MAN" button on the display <b>Single measurement</b>
		Start sequence	Corresponds to the "AUTO" button on the display <b>Automatic measurement</b>
		Stop sequence	Corresponds to the "STOP" button on the display

			<b>Abort</b> automatic measurement (not yet in function/bug)
#3	Display	Quantity	Number of measurements / stored measured values
		Measured value	Current measured value of the last measurement
		Mean value	Mean value of the measurement series
		Sigma	Standard deviation of the measurement series: $\sigma_{n-1} = \sqrt{\frac{1}{n-1} \sum_{i=1}^n (x_i - \bar{x})^2}$
		Min/Max	Minimum/maximum of the measurement series
#4	Chart		<b>Display measured values graphically</b> Abscissa: measurement number Ordinates: measured value, mean value and sigma ToolTip function mouse cursor over data point displays measured value
#5		Save	Saving the measured values in a CSV file

## 6. ERROR MESSAGES

Item	Error	Output to interface
1	No communication with dial gauge	"Error 100"
2	Error initialisation of dial gauge	"Error 101"
3	Raising measuring sensor timeout	"Error 200"
4	Lowering measuring sensor timeout	"Error 201"
5	Invalid configuration of the device	"Memory error"
6	Operating elements malfunction	"Error 210"

	Possible cause	Remedy
1	Dial gauge not connected or incorrectly connected	Connecting the dial gauge correctly
	Dial gauge defective	Replace dial gauge
2	Selected resolution (RES1...3) does not match dial gauge	Change resolution or Connect the dial gauge with resolution
3	Limit switch defective or displaced	Check limit switch
4	Limit switch defective or displaced	Check limit switch
5	No configuration stored	Save configuration again
	Configuration stored incorrectly	Save configuration again

## 7. DESCRIPTION OF THE USB INTERFACE

A microcontroller of the STM32 series from STMicroelectronics drives the control board. The USB interface of the microcontroller can be used for communication or for programming (update) by means of a connected PC. In addition, a virtual serial interface is provided.

The basic configuration is set via the USB-HID interface and does not require any additional drivers. The operating program itself only needs the .NET runtime environment.

### 7.1 Installing the USB driver for program updates

This software is required if a software update is to be carried out over the USB interface.

Software	Description	Provision
.NET framework V4.5 or higher	Runtime environment for GETT_USB_FW_Updater	-
ST Micro DfuSe Demo	Drivers and DLLs for STM32 DFU devices ..\ProgrammingTool\STM32_Dfuse_Driver	GETT
GETT_USB_FW_Updater	Programming software GETT USB FW Updater ..\Programming Tool\GET USB FW Updater	GETT

### 7.2 Installing the USB driver for the virtual serial interface

This driver is required for Windows 7 if the serially output measured values are to be read in. The driver simulates a serial interface in the PC.

#### Procedure

Start Device Manager (start search entry: "Device Manager")

Search for unconnected device with [www.gett.de](http://www.gett.de)

Update driver, specify search folder

..\Driver\_USB\_VirtualCOM\st-link\_009\_ST\_Link2\_usbdrv

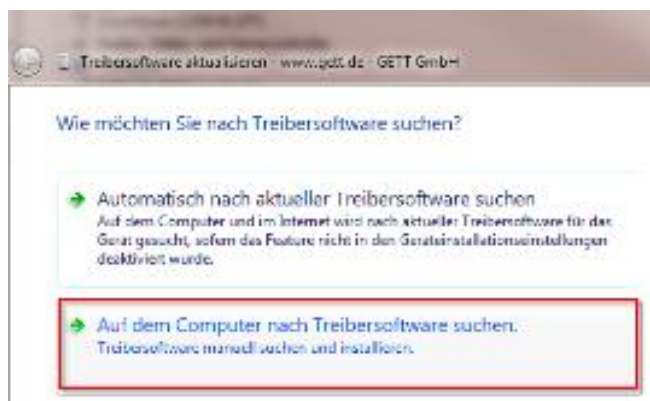
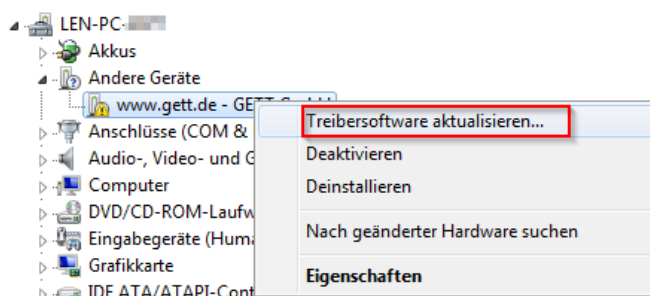

Confirmation of driver installation

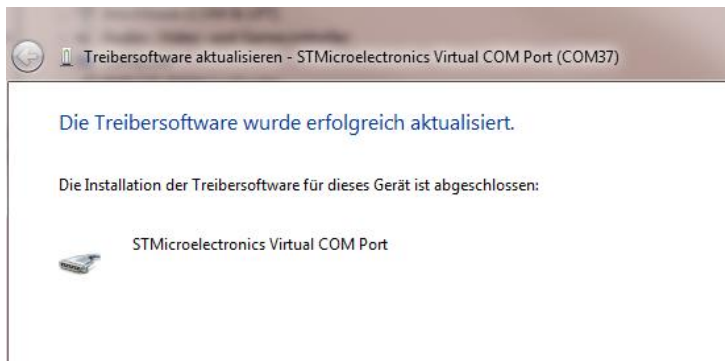

### 7.3 Output of measurement data

The following data is output.

Unit

Number of the current measurement or number of measurements

Actual value of the current measurement

Mean value

Standard deviation  $\sigma_{N-1}$

The measurement data is output in ASCII character format. The entries are marked with **@UNIT** for the unit, **@ANZ** for the measured value number, **@IST** for the measured value, **@MWT** for the mean value and **@STW** for the standard deviation.

### 7.4 Interface

Settings: Baud rate 9600,8,N,1





## 9. TECHNICAL PARAMETERS

Units of measurement:	mm / inch (adjustable)
Measuring system:	capacitive
Measuring depth:	110mm
Test surface and surface pressure:	according to international standards DIN, EN and ISO
Data output:	USB / RS232
Temperature range:	10-45°C
Dimensions:	(depends on model) 300 x 200 x 300 mm [L x W x H]
Net weight:	about 25 kgs
Supply voltage:	24V (1.25A)
Power supply input voltage:	100-240V (0.8A /50-60Hz)

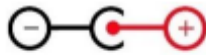

Distributed by:



**Checkline Europe GmbH & Co. KG** ®  
Warschauerstrasse 8  
48455 Bad Bentheim  
Deutschland

Tel: +49 5924 9999 690  
Web: <https://www.checkline.de>  
E-mail: [info@checkline.de](mailto:info@checkline.de)